

LAMPIRAN A

LAMPIRAN A

SPESIFIKASI AKSESORIS DAN PELENGKAP PENGOLAHAN

A.1 Spesifikasi Intake



Gambar A- 1 Grundfos NK 250-350/227

A.2 Spesifikasi Prasedimentasi

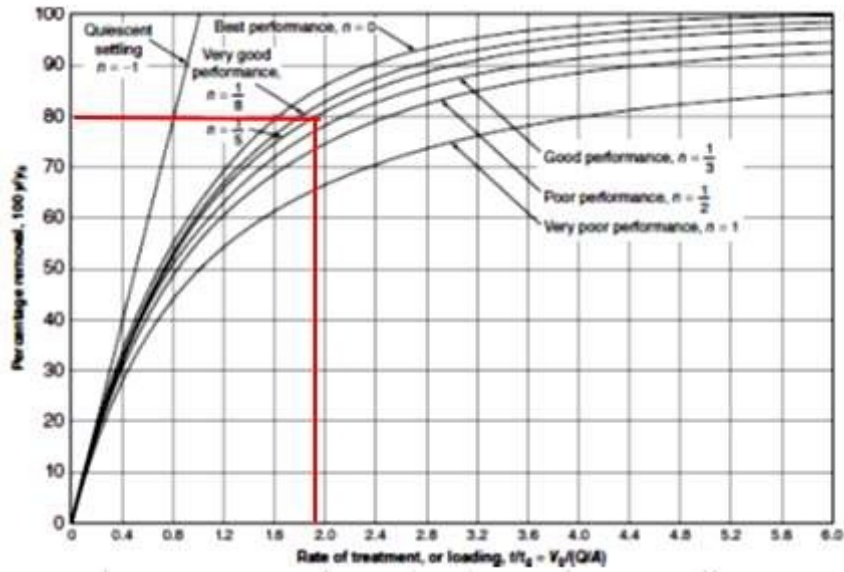

Gambar A- 2 Performance curves for settling basin of varying effectiveness

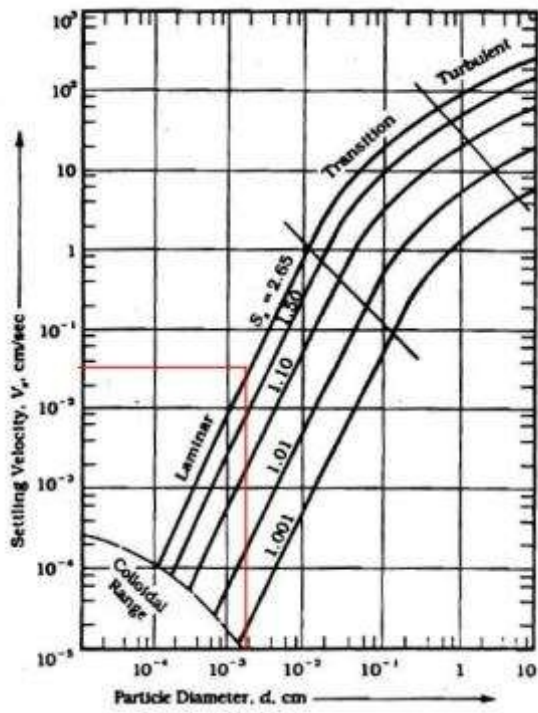

A.3 Spesifikasi Aerasi



Gambar A- 3 Aeration Nozzles

BETE

BETE Fog Nozzle, Inc.
50 Greenfield St
Greenfield MA 01301 USA
www.bete.com | 413-772-0846 | 800-235-0049

SPRAY NOZZLE DATA SHEET - 1 1/2TF64FCN-B@4

MECHANICAL DATA

Connection Size	1 1/2 Pipe
Connection Type	M BSP
Nozzle Series	TF
Rating	64
Spray Angle	90°
Spray Pattern	Full Cone
Nozzle Style	Spiral
Material	Brass
BETE Material Code	4
Weight	22.0 oz
Orifice Diameter	1.00 in
Free Passage	.310 in



This image is representative of this nozzle series. The specific part described on this datasheet may have a different appearance.

The stated material corresponds to the product description listed above. This nozzle is available in a wide range of materials; contact BETE for other available materials.

PROJECTED PERFORMANCE DATA

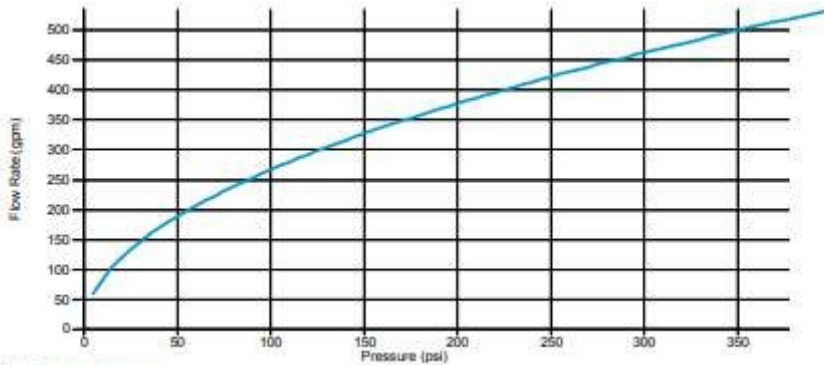

NOTES: [Series Webpage](#)

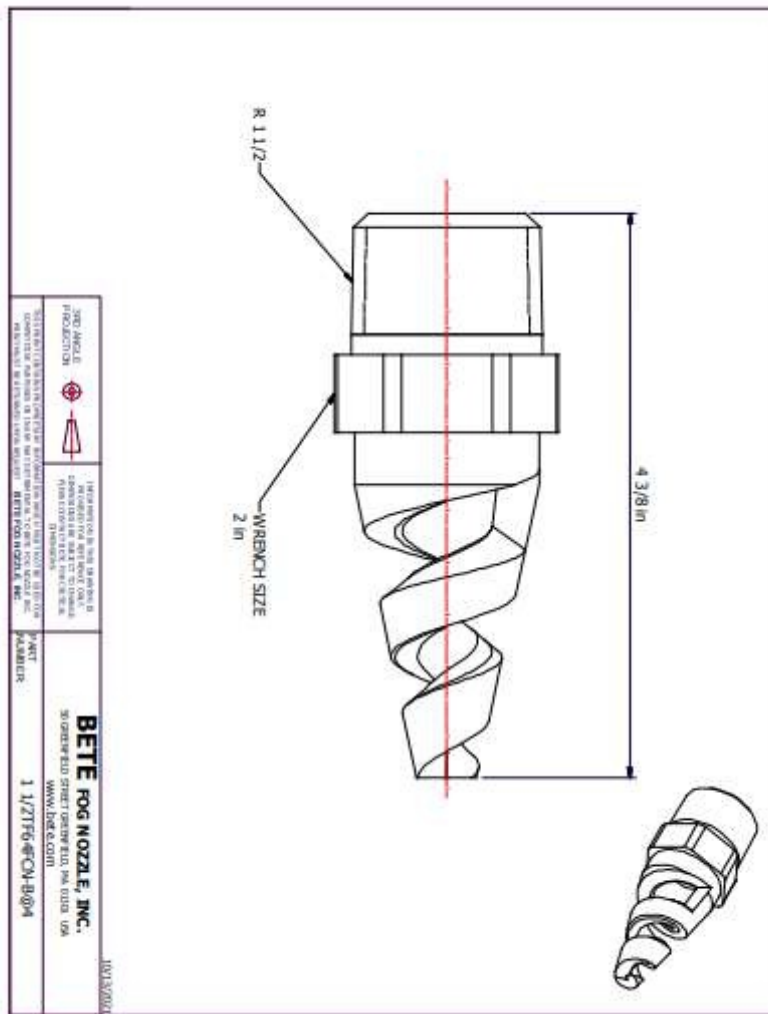

A.4 Spesifikasi Koagulasi

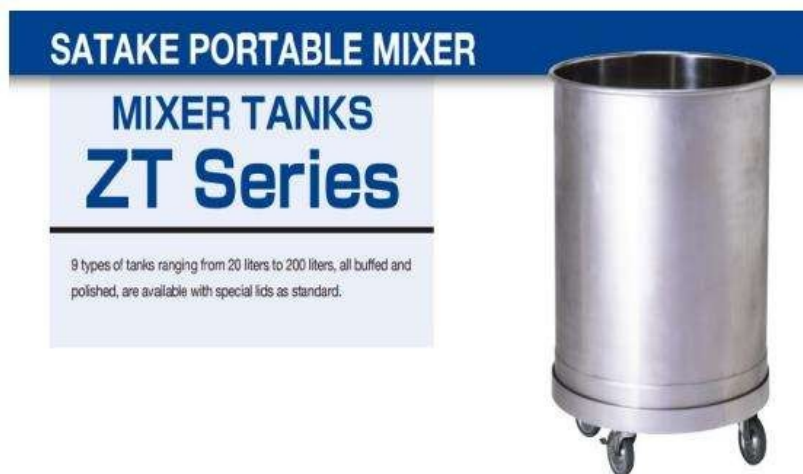

Gambar A- 4 Satake Portable Mixer (ZT Series)

Specification of optional tanks

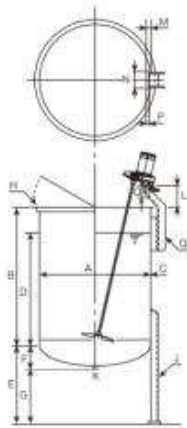

Model	Available capacity		Maximum capacity	Tank dimension (mm)													Weight (kg)	
	l	l'		A	B	C	D	E	F	G	H(BJS)	JSS	K	Tank	Lid			
ZTF-100	100	130	500	600	3	450	450	134	316	L25x25x3	3-L50x50x6	1/2 B Socket	43	3				
ZTF-150	150	182	550	700	3	562	450	144	306	L30x30x3	3-L50x50x6	1/2 B Socket	51	4				
ZTF-200	200	260	650	700	3	520	450	163	267	L30x30x3	3-L50x50x6	1/2 B Socket	80	5.5				
ZTF-300	300	361	700	850	3	692	500	173	327	L40x40x3	4-L50x50x6	1/2 B Socket	77	6.5				
ZTF-400	400	478	800	850	3	695	500	192	308	L40x40x3	4-L50x50x6	1/2 B Socket	88	8				
ZTF-500	500	800	850	950	3	770	500	202	296	L40x40x3	4-L65x65x6	1/2 B Socket	106	9				
ZTF-800	800	963	1000	1100	3	900	550	240	310	L40x40x5	4-100x50x5	1B Socket	155	12				
ZTF-1000	1000	1177	1100	1100	3	910	550	260	290	L40x40x5	4-100x50x5	1B Socket	170	18				
ZTF-1500	1500	1721	1250	1245	4	1086	600	290	310	L40x40x5	4-100x50x5	1B Socket	260	24				
ZTF-2000	2000	2275	1300	1590	4	1345	600	298	302	L50x50x6	4-125x65x6	1B Socket	335	28				
ZTF-2000S	2000	2273	1400	1300	4	1125	600	318	282	L50x50x6	4-125x65x6	1B Socket	325	30				
ZTF-2500	2500	3073	1500	1550	4	1230	700	370	330	L50x50x6	4-125x65x6	1B JIS 10KF	400	34				
ZTF-3000	3000	3603	1500	1850	4	1510	700	370	330	L50x50x6	4-125x65x6	1B JIS 10KF	448	34				
ZTF-3000S	3000	3921	1600	1590	4	1290	750	400	350	L50x50x6	4-125x65x6	1B JIS 10KF	422	38				
ZTF-3500	3500	4125	1600	1850	4	1540	700	400	300	L50x50x6	4-150x75x9	1B JIS 10KF	524	38				
ZTF-3500S	3500	4004	1700	1550	4	1330	800	430	370	L50x50x6	4-150x75x9	1B JIS 10KF	514	43				
ZTF-4000	4000	4685	1700	1800	4	1550	800	430	370	L65x65x6	4-150x75x9	1 1/2 B JIS 10KF	575	45				
ZTF-4000S	4000	4520	1800	1500	4	1345	800	450	350	L65x65x6	4-150x75x9	1 1/2 B JIS 10KF	550	50				
ZTF-4500	4500	5285	1800	1850	5	1542	800	450	350	L65x65x6	4-200x90x8	1 1/2 B JIS 10KF	750	50				
ZTF-5000	5000	5924	1900	1850	5	1530	900	500	400	L65x65x6	4-200x90x8	2B JIS 10KF	800	56				

* The lids have a thickness of 1.3t for A dimension up to 1000, and 2.0t for A dimension above that.
 † Jacket type is also available.

Gambar A- 5 ZT Series/ZTF-3000

External Dimensions

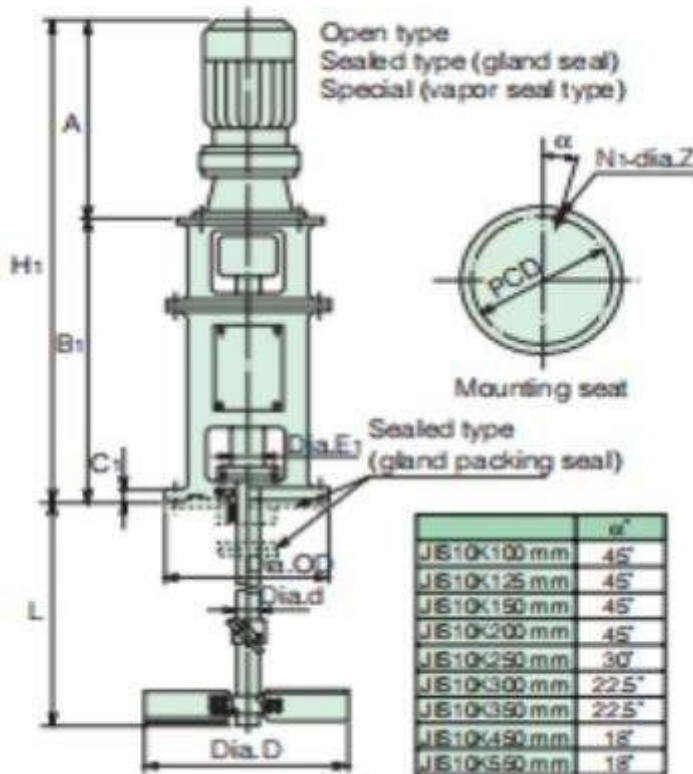

Specification Dimensions

Model	Motor Output kW	Gear Reducer		Revolution speed (rpm)		Agitation Shaft		Frame Flange Diameter (D ₁) mm	Mounting Flange				No. Agitation Cores		Motor Weight kg		
		Frame No.	Gear Ratio	10 Hz	60 Hz	Standard Length (L) mm	Dia. (D) mm		Normal Dia. 45-245 mm	Outer Dia. 60-305 mm	PC (D) mm	Ø1 mm	Ø2 mm	Ø3 mm		Ø4 mm	Ø5 mm
C2T□-0.1	0.1	4075	V11	136	164			200								19	
			V17	88	106			250								19	
			V39	52	62	1000	16	350	100 mm	210	175	10	4			30	
			V35	43	51			400								21	
			V43	35	42			450								21	
			V59	25	31	1200	22	500	125 mm	250	210	23	4			29	
C2T□-0.2	0.2	4085	V47	17	21			700	150 mm	280	240	23	4		50		
			V11	136	164	1000	16	230	100 mm	210	175	10	4		20		
			V17	88	106			350								21	
			V39	52	62			400								28	
			V35	43	51	1200	22	500	125 mm	250	210	23	4	1300	100	30	
			V43	35	42			550								30	
C2T□-0.4	0.4	4095	V39	25	31			800	150 mm	280	240	23	4		50		
			V47	17	21	1500	32	1100							50		
			V11	136	164			320								39	
			V17	88	106	1200	22	400	125 mm	250	210	23	4			35	
			V35	43	51			550								50	
			V43	35	42			600								51	
C2T□-0.75	0.75	4105	V43	35	42			650	150 mm	280	240	23	4		2500	1300	61
			V47	17	21	1500	32	800								61	
			V59	25	31			900								60	
			V43	35	42			1150								74	
			V47	17	21	1500	32	700	150 mm	280	240	23	4			58	
			V35	43	51			800								63	
C2T□-1.5	1.5	4115	V43	35	42			900							67		
			V39	25	31	2000	45	1000	200 mm	330	290	23	4			130	
			V47	17	21			1350								174	
			V11	136	164	1500	32	500	150 mm	280	240	23	4			59	
			V17	88	106			600								61	
			V39	25	31	2200	45	800	200 mm	330	290	23	4	10000	5000	123	
C2T□-2.2	2.2	4130	V43	35	42			1000							127		
			V47	17	21	2400	50	1300								130	
			V59	25	31			1500								134	
			V43	35	42			1750								167	
			V11	136	164	1500	32	650	150 mm	280	240	23	4			63	
			V17	88	106			700								123	
C2T□-3.7	3.7	4135	V39	25	31	2000	45	950	200 mm	330	290	23	4			130	
			V43	35	42			1050								137	
			V47	17	21	2600	60	1150								209	
			V59	25	31			1300								221	
			V43	35	42			1750								339	
			V11	136	164	2200	45	600	200 mm	330	290	23	4			132	
C2T□-5.5	5.5	4150	V17	88	106			750								130	
			V39	25	31	2400	50	1000								215	
			V43	35	42			1200								223	
			V47	17	21	2600	60	1300								265	
			V59	25	31			1500								308	
			V11	136	164	2800	70	1250	300 mm	445	400	23	8			330	

Gambar A- 6 Catalog Tacmina Agrigator

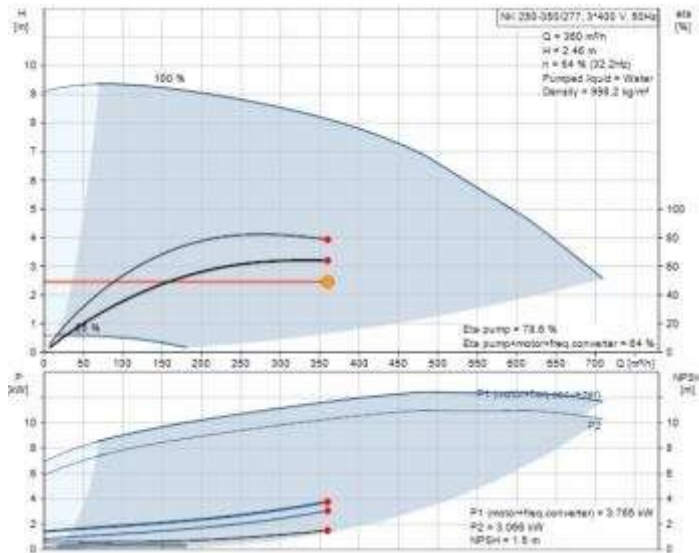

Qty. Description

1 NK 250-350ZT1 AA3F1ABSBADENWS



Note! Product picture may differ from actual product.

Product No.: 56318770

Non-self-priming, single-stage, centrifugal volute pump designed according to ISO 5166 with dimensions and rated performance according to EN 733. Flanges are PN 10 with dimensions according to EN 1092-2. The pump has an axial suction port, a radial discharge port and horizontal shaft. It is of the back pull-out design enabling removal of the coupling, bearing bracket and impeller without disturbing the motor, pump housing or pipework.

The unbalanced rubber bellows seal is according to DIN EN 12758.

The pump is fitted with a foot-mounted, fan-cooled asynchronous motor. Pump and motor are mounted on a common base frame.

Controls:

Frequency converter: NONE
Pressure sensor: N

Liquid:

Pumped liquid: Water
Liquid temperature range: 0 - 120 °C
Density: 999.7 kg/m³

Technical

Pump speed on which pump data are based: 975 rpm
Actual calculated flow: 360 m³/h
Pump with motor (Yes/No): Y
Resulting head of the pump: 2.46 m
Actual impeller diameter: 277 mm
Nominal impeller diameter: 300
Code for shaft seal: BAGE
Mechanical seal type: Single
Curve tolerance: ISO9906:2012 B8
Bearing design: Standard

Materials:

Pump housing: Cast iron
EN-GJL-250
ASTM class 35
Wear ring: Brass
Impeller: Cast iron
EN-GJL-200
ASTM class 30
Shaft: Stainless steel
EN 1.4301
AISI 304
Internal pump house coating: CED

Installation:

Maximum ambient temperature: 55 °C
Maximum operating pressure: 10 bar
Pipe connection standard: EN 1092-2
Type of inlet connection: DN



Company name:

Created by:

Phone:

Date: 03/10/2021

Qty.	Description
	Type of outlet connection: DN
	Size of inlet connection: DN 300
	Size of outlet connection: DN 250
	Pressure rating for connection: PN 10
	Coupling type: Flexible wispacer
	Base frame design: EN150
	Grouting (Yes/No): N
	Electrical data:
	Motor type: SIEMENS
	IE Efficiency class: IE3
	Rated power - P2: 11 kW
	Main frequency: 50 Hz
	Rated voltage: 3 x 380-420/660-725V V
	Rated current: 22.0/12.7 A
	Starting current: 600-680 %
	Cos phi - power factor: 0.85
	Rated speed: 880 rpm
	Efficiency: IE3 80.3%
	Motor efficiency at full load: 80.3-80.3 %
	Motor efficiency at 75 load: 80.7-80.7 %
	Motor efficiency at 1/2 load: 80.3-80.8 %
	Number of poles: 6
	Enclosure class (IEC 34-5): IP55
	Insulation class (IEC 85): F
	Motor No: 8857450
	Other:
	Minimum efficiency index, MEI is: 0.70
	Net weight: 686 kg
	Gross weight: 1080 kg
	Shipping volume: 2.53 m ³

Specification of optional tanks

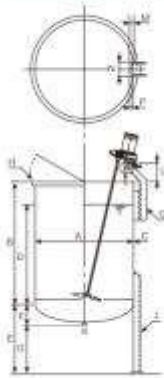

Model	Analyse capacity		Maximum capacity		Tank dimension (mm)										Weight (kg)	
	F	F'	A	B	C	D	E	F	G	H(S)	J(S)	K	Tank	Lot		
ZTF-100	100	130	500	600	3	450	450	134	316	1.25-20-3	3-1.50-50-6	1 1/2 B Socket	43	3		
ZTF-150	150	180	550	700	3	500	450	144	304	1.50-30-3	3-1.50-50-6	1 1/2 B Socket	51	4		
ZTF-200	200	260	650	700	3	500	400	163	267	1.50-30-3	3-1.50-50-6	1 1/2 B Socket	80	5.3		
ZTF-300	300	361	750	850	3	682	500	173	307	1.40-40-3	4-1.50-50-6	1 1/2 B Socket	77	6.3		
ZTF-400	400	478	800	850	3	885	500	190	308	1.40-40-3	4-1.50-50-6	1 1/2 B Socket	88	8		
ZTF-500	500	600	850	950	3	775	500	200	298	1.40-40-3	4-1.50-50-6	1 1/2 B Socket	106	9		
ZTF-800	800	860	1000	1100	3	800	500	240	310	1.40-40-3	4-1.50-50-6	1 B Socket	150	12		
ZTF-1000	1000	1177	1100	1100	3	910	600	260	290	1.40-40-3	4-1.50-50-6	1 B Socket	170	18		
ZTF-1500	1500	1721	1250	1245	4	1065	600	290	310	1.40-40-3	4-1.50-50-6	1 B Socket	260	24		
ZTF-2000	2000	2276	1500	1550	4	1345	600	298	300	1.40-40-3	4-1.50-50-6	1 B Socket	355	26		
ZTF-2000S	2000	2270	1400	1300	4	1125	600	318	280	1.40-40-3	4-1.50-50-6	1 B Socket	325	30		
ZTF-2500	2500	3073	1600	1550	4	1230	700	370	320	1.50-50-6	4-1.50-50-6	1 B JS 10KF	400	34		
ZTF-3000	3000	3890	1600	1850	4	1510	700	370	350	1.50-50-6	4-1.50-50-6	1 B JS 10KF	448	34		
ZTF-3000S	3000	3521	1600	1550	4	1290	750	400	350	1.50-50-6	4-1.50-50-6	1 B JS 10KF	422	38		
ZTF-3500	3500	4105	1600	1850	4	1540	700	400	300	1.50-50-6	4-1.50-75-9	1 B JS 10KF	524	38		
ZTF-3500S	3500	4004	1700	1850	4	1320	800	450	370	1.50-50-6	4-1.50-75-9	1 B JS 10KF	514	42		
ZTF-4000	4000	4998	1700	1850	4	1560	800	480	370	1.60-60-6	4-1.50-75-9	1 1/2 B JS 10KF	575	45		
ZTF-4000S	4000	4500	1800	1500	4	1345	800	480	380	1.60-60-6	4-1.50-75-9	1 1/2 B JS 10KF	560	50		
ZTF-4500	4500	5385	1800	1850	5	1540	800	450	380	1.60-60-6	4-1.50-90-9	1 1/2 B JS 10KF	750	50		
ZTF-5000	5000	5924	1800	1850	5	1530	900	600	400	1.60-60-6	4-1.50-90-9	2 B JS 10KF	800	58		

*The ribs have a thickness of 1.5t for A dimension up to 1000, and 2.0t for A dimension above that.
 † Jacket type is also available.

Gambar A- 7 ZT Series/ZTF-5000

External Dimensions

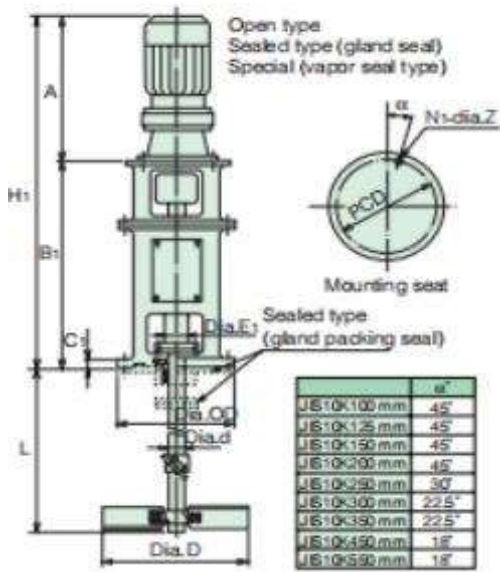

Specification Dimensions

Model	Motor Output		Gear Reducer		Rotation speed (rpm)		Agitator Shaft		Pilot Cycle Valve	Mounting Flange				No. of Motor Leads	Approx. Weight (kg)											
	kW	HP	Frame No.	Gear Ratio	50 Hz	60 Hz	Standard Length (L) mm	Dia. (D) mm		100mm Dia. (D) mm	150mm Dia. (D) mm	200mm Dia. (D) mm	250mm Dia. (D) mm													
CFF □ 0.1	0.1	0.11	30	154	100	16	200	100mm	200	200	200	200	4	100	300											
																317	88	306	230							
																475	329	52	42	500	150mm	200	175	19	4	
																528	49	21	100	100	100	100	100	100	100	100
																743	35	42	100	100	100	100	100	100	100	100
CFF □ 0.2	0.2	0.11	30	154	100	16	200	100mm	200	200	200	200	4	100	300											
																317	88	306	230							
																475	329	52	42	500	150mm	200	175	19	4	
																528	49	21	100	100	100	100	100	100	100	100
																743	35	42	100	100	100	100	100	100	100	100
CFF □ 0.4	0.4	0.11	30	154	100	16	200	100mm	200	200	200	200	4	100	300											
																317	88	306	230							
																475	329	52	42	500	150mm	200	175	19	4	
																528	49	21	100	100	100	100	100	100	100	100
																743	35	42	100	100	100	100	100	100	100	100
CFF □ 0.75	0.75	0.11	30	154	100	16	200	100mm	200	200	200	200	4	100	300											
																317	88	306	230							
																475	329	52	42	500	150mm	200	175	19	4	
																528	49	21	100	100	100	100	100	100	100	100
																743	35	42	100	100	100	100	100	100	100	100
CFF □ 1.5	1.5	0.11	30	154	100	16	200	100mm	200	200	200	200	4	100	300											
																317	88	306	230							
																475	329	52	42	500	150mm	200	175	19	4	
																528	49	21	100	100	100	100	100	100	100	100
																743	35	42	100	100	100	100	100	100	100	100
CFF □ 2.2	2.2	0.11	30	154	100	16	200	100mm	200	200	200	200	4	100	300											
																317	88	306	230							
																475	329	52	42	500	150mm	200	175	19	4	
																528	49	21	100	100	100	100	100	100	100	100
																743	35	42	100	100	100	100	100	100	100	100
CFF □ 3.7	3.7	0.11	30	154	100	16	200	100mm	200	200	200	200	4	100	300											
																317	88	306	230							
																475	329	52	42	500	150mm	200	175	19	4	
																528	49	21	100	100	100	100	100	100	100	100
																743	35	42	100	100	100	100	100	100	100	100

A.5 Spesifikasi Sedimentasi

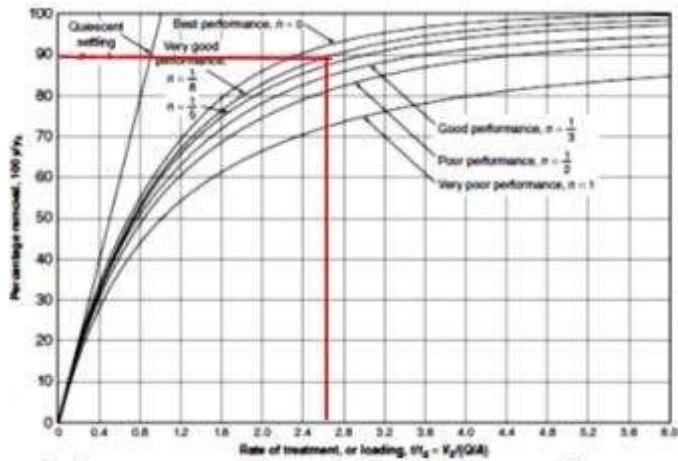

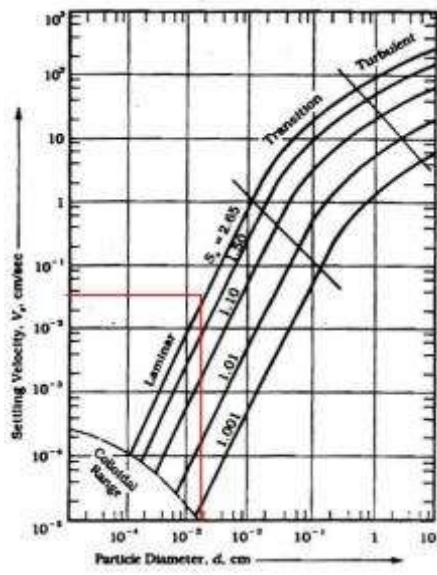

A.6 Spesifikasi Desinfeksi

DMX 50-10 B-SS/T/SS-X-E1AAXEMNG





Company name:

Created by:

Phone:

Date:

16/11/2021

Qty.	Description
	<p>Pumped liquid: Water</p> <p>Liquid temperature range: -10 .. 70 °C</p> <p>Selected liquid temperature: 20 °C</p> <p>Density: 998.2 kg/m³</p> <p>Technical:</p> <p>Nominal flow rate at 50 Hz: 0.833 l/min</p> <p>Number of dosing heads: 1</p> <p>Approvals: CE, EAC, CNROHSEX</p> <p>Non return valve type, inlet pump 1: Standard</p> <p>Non return valve type, outlet pump 1: Standard</p> <p>Max viscosity: 100 mPas</p> <p>Materials:</p> <p>Pump housing: Thermoplastic</p> <p>Dosing head, pump 1: Stainless steel EN 1.4571</p> <p>Valve ball: Stainless steel EN 1.4401</p> <p>Valve seat: Composite</p> <p>Valve gasket: PTFE Composite</p> <p>Installation:</p> <p>Max operating pressure at 50 Hz: 10 bar</p> <p>Maximum permissible inlet pressure: 0 bar</p> <p>Type of inlet connection: Rp</p> <p>Type of outlet connection: Rp</p> <p>Size of inlet connection: 1/4 inch</p> <p>Size of outlet connection: 1/4 inch</p> <p>Electrical data:</p> <p>Power input P1: 0.09 kW</p> <p>Mains frequency: 50 Hz</p> <p>Rated voltage: 3 x 230/400 V</p> <p>Enclosure class (IEC 34-5): IP65</p> <p>Cable included (Yes/No): N</p> <p>Power plug: NO PLUG</p> <p>Others:</p> <p>Net weight: 9 kg</p> <p>Gross weight: 11.8 kg</p> <p>Shipping volume: 0.04 m³</p> <p>Diaphragm Leakage Detection: N</p> <p>Country of origin: DE</p> <p>Custom tariff no.: 841350</p>

LAMPIRAN B



UNIVERSITAS PEMBANGUNAN NASIONAL
"VETERAN" JAWA TIMUR
FAKULTAS TEKNIK
PROGRAM STUDI TEKNIK LINGKUNGAN

MATA KULIAH

TUGAS PBPAM

DOSEN PEMBIMBING

RADEN KOKOH H.P., ST.,MT.,

MAHASISWA

ANA MAUDIAUL K
NADA HEKTI PRATIWI
HELFIYA NORISTIA P.

NPM

18034010008
18034010009
18034010037

GAMBAR

LAYOUT BANGUNAN

SKALA

1: 1200

KETERANGAN

1. INTAKE DAN BARSREEN
2. PRASEDIMENTASI
3. SPRAY AERATOR
4. KOAGULASI
5. FLOKULASI
6. SEDIMENTASI
7. FILTRASI
8. DESINFEKSI
9. SLUDGE DRYING BED

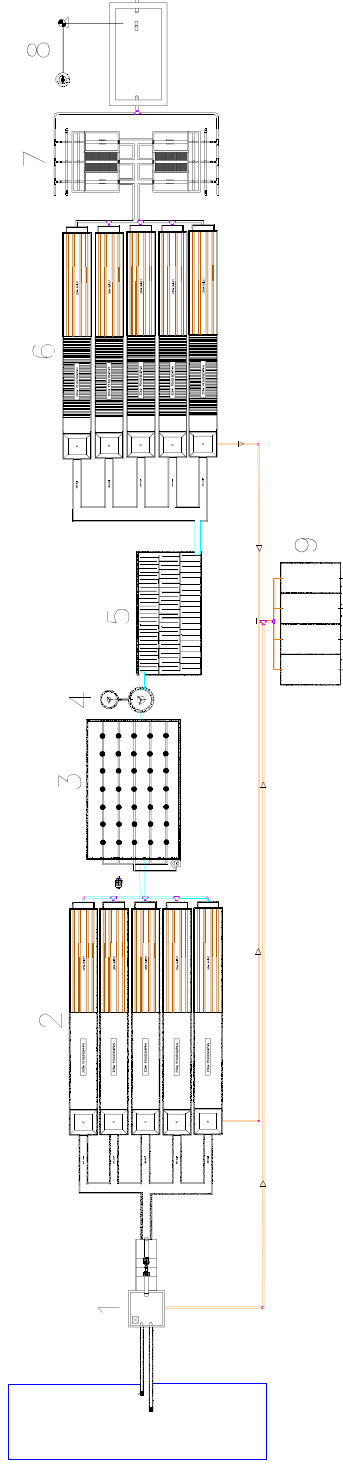

LEMBAR KE

JUMLAH

TANGGAL ACC



UNIVERSITAS PEMBANGUNAN NASIONAL
"VETERAN" JAWA TIMUR
FAKULTAS TEKNIK
PROGRAM STUDI TEKNIK LINGKUNGAN

MATA KULIAH

TUGAS PBPAM

DOSEN PEMBIMBING

RADEN KOKOH H.P., ST.,MT.,

MAHASISWA

ANA MAUDIA K.
NADA HEKTI PRATIWI
HELFIYA NORISTA P.

NPM

18034010008
18034010009
18034010037

GAMBAR

PROFIL HIDRAULIS

SKALA

1: 1200

KETERANGAN

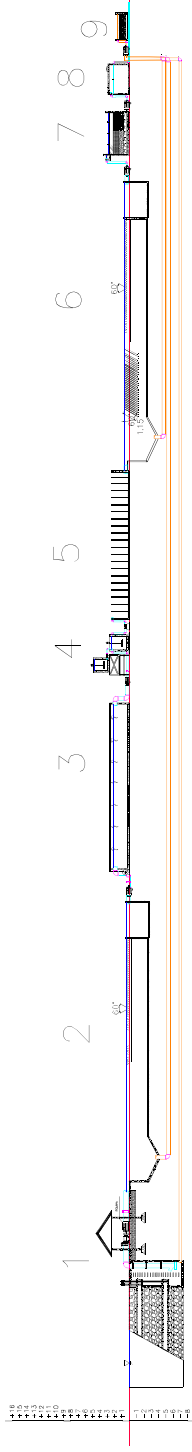

1. INTAKE DAN BARSCREEN
2. PRASEDIMENTASI
3. SPRAY AEFATOR
4. KOAGULASI
5. FLOKULASI
6. SEDIMENTASI
7. FILTRASI
8. DESINFEKSI
9. SLUDGE DRYING BED

PROFIL HIDRAULIS



LEMBAR KE	JUMLAH	TANGGAL ACC



UNIVERSITAS PEMBANGUNAN NASIONAL
"VETERAN" JAWA TIMUR
FAKULTAS TEKNIK
PROGRAM STUDI TEKNIK LINGKUNGAN

MATA KULIAH

TUGAS PBPAM

DOSEN PEMBIMBING

RADEN KOKOH H.P., ST.,MT.,

MAHASISWA

ANA MAUDJATUL K.
18034010009
NANDA HENIK PRATIWI
18034010032
HAFIQYA NORISTA P.
18034010037

NPM

GAMBAR

INTAKE DAN SUMUR
PENGUMPUL

SKALA

1:40

KETERANGAN

LEMBAR KE

JUMLAH

TANGGAL/ACC

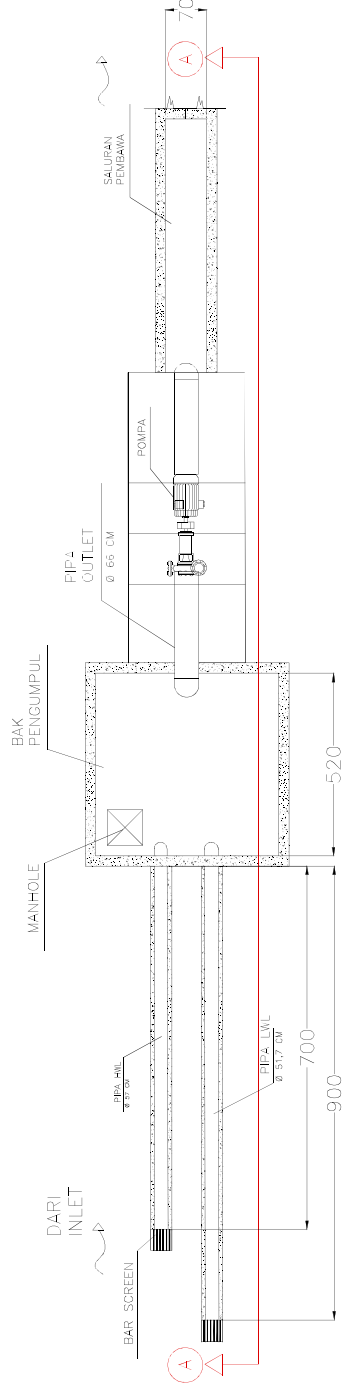

DENAH INTAKE DAN SUMUR PENGUMPUL
TAMPAK ATAS



UNIVERSITAS PEMBANGUNAN NASIONAL
"VETERAN" JAWA TIMUR
FAKULTAS TEKNIK
PROGRAM STUDI TEKNIK LINGKUNGAN

MATA KULIAH

TUGAS PBPAM

DOSEN PEMBIMBING

RADEN KOKOH H.P., ST.,MT.,

MAHASISWA

ANA MAUDATUL K.
18034010009
NANDA HENIK PRATIWI
18034010032
HAFIQYAH NORISTA P.
18034010037

GAMBAR

INTAKE

SKALA

1:80

KETERANGAN

LEMBAR KE JUMLAH TANGGAL/ACC

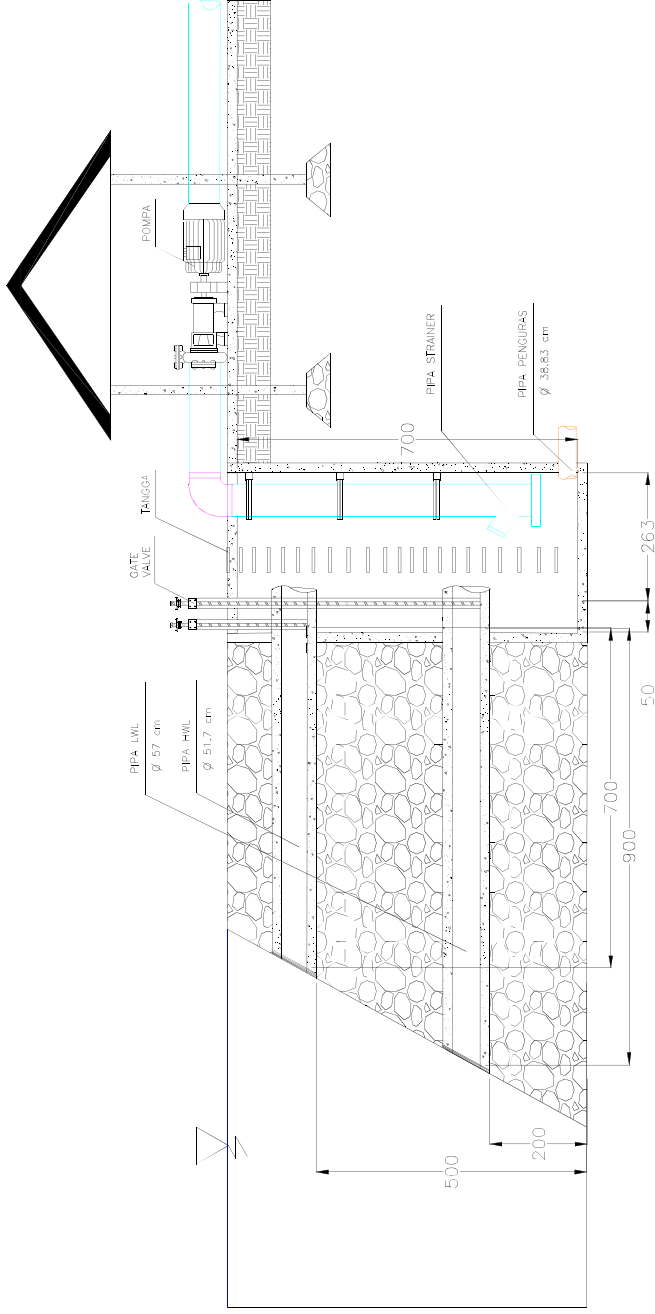

DENAH INTAKE DAN SUMUR PENGUMPUL

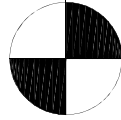



UNIVERSITAS PEMBANGUNAN NASIONAL
"VETERAN" JAWA TIMUR
FAKULTAS TEKNIK
PROGRAM STUDI TEKNIK LINGKUNGAN

MATA KULIAH

TUGAS PBPAM

DOSEN PEMBIMBING

RADEN KOKOH H.P., ST.,MT.,

MAHASISWA

ANA MAUDATUL K.
18034010009
NANDA HENIK PRATIWI
18034010032
HAIDYA NORISTA P.
18034010037

NPM

GAMBAR

PRASEDIMENTASI

SKALA

1:40

KETERANGAN

LEMBAR KE	JUMLAH	TANGGAL/ACC
-----------	--------	-------------

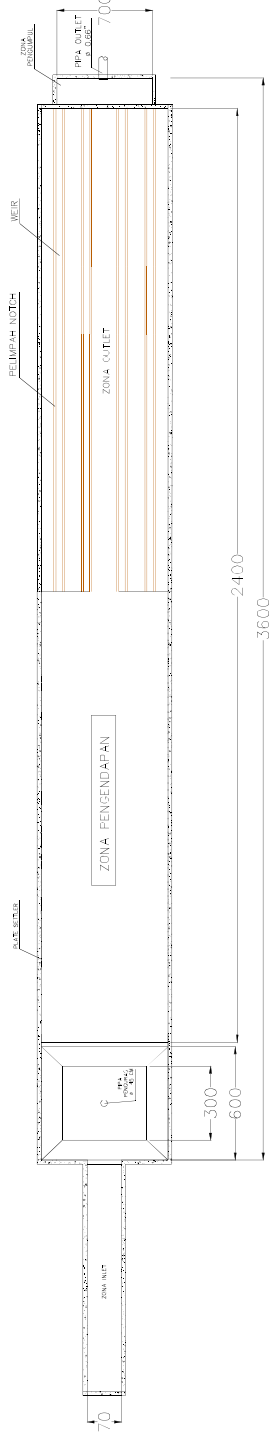

PRASEDIMENTASI
TAMPAK ATAS



UNIVERSITAS PEMBANGUNAN NASIONAL
"VETERAN" JAWA TIMUR
FAKULTAS TEKNIK
PROGRAM STUDI TEKNIK LINGKUNGAN

MATA KULIAH

TUGAS PBPAM

DOSEN PEMBIMBING

RADEN KOKOH H.P., ST.,MT.,

MAHASISWA

NPM
ANA MAUDATUL K. 18034010009
NANDA HENIK PRATIWI 18034010032
HAFIDYA NORISTA P. 18034010037

GAMBAR

PRASEDIMENTASI

SKALA

1:40

KETERANGAN

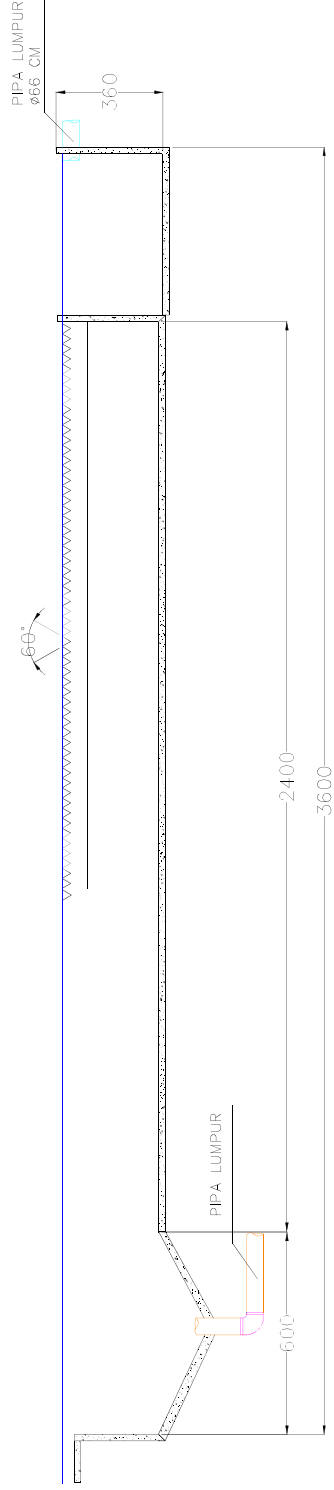

PRASEDIMENTASI
POTONGAN A-A

LEMBAR KE JUMLAH TANGGAL/ACC



UNIVERSITAS PEMBANGUNAN NASIONAL
"VETERAN" JAWA TIMUR
FAKULTAS TEKNIK
PROGRAM STUDI TEKNIK LINGKUNGAN

MATA KULIAH

TUGAS PBPAM

DOSEN PEMBIMBING

RADEN KOKOH H.P., ST.,MT.,

MAHASISWA

ANA MAUDIA TUL K.
18034010009
NANDA HENIK PRATIWI
18034010032
HAFIDYA NORISTA P.
18034010037

NPM

GAMBAR

PFASEDIMENTASI

SKALA

1:40

KETERANGAN

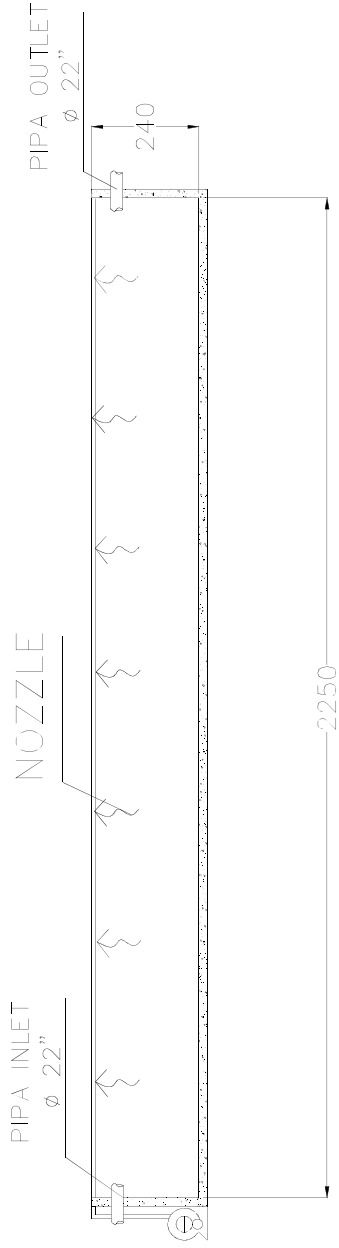

SPRAY AERATOR
POTONGAN A-A

LEMBAR KE	JUMLAH	TANGGAL/ACC



UNIVERSITAS PEMBANGUNAN NASIONAL
"VETERAN" JAWA TIMUR
FAKULTAS TEKNIK
PROGRAM STUDI TEKNIK LINGKUNGAN

MATA KULIAH

TUGAS PBPAM

DOSEN PEMBIMBING

RADEN KOKOH H.P., ST.,MT.,

MAHASISWA

NPM

ANA MAUDIA TUL K.
18034010009
NANDA HENIK PRATIWI
18034010032
HAFIDYA NORISTA P.
18034010037

GAMBAR

SPRAY AERATOR

SKALA

1:40

KETERANGAN

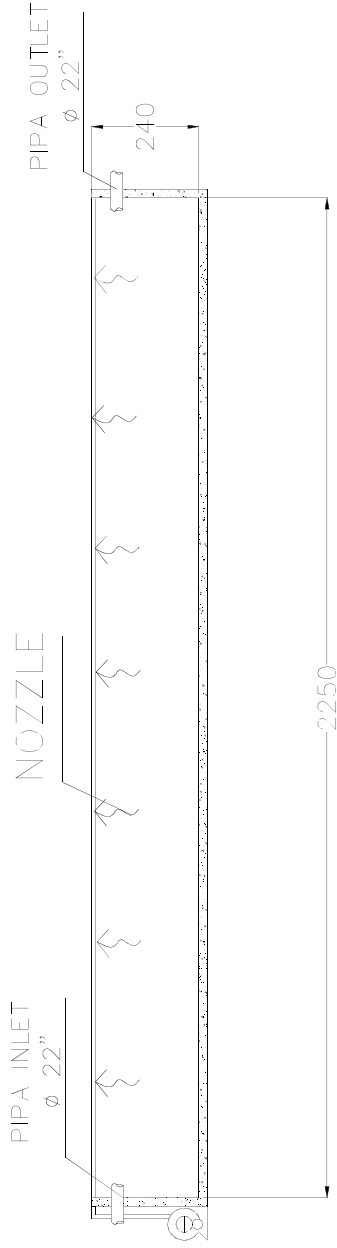

SPRAY AERATOR
POTONGAN A-A

LEMBAR KE	JUMLAH	TANGGAL/ACC



UNIVERSITAS PEMBANGUNAN NASIONAL
"VETERAN" JAWA TIMUR
FAKULTAS TEKNIK
PROGRAM STUDI TEKNIK LINGKUNGAN

MATA KULIAH

TUGAS PBPAM

DOSEN PEMBIMBING

RADEN KOKOH H.P., ST.,MT.,

MAHASISWA

ANA MAUDATUL K. 18034010009
NANDA HENIK PRATIWI 18034010032
HAFIQYAH NORISTA P. 18034010037

MAHASISWA

ANA MAUDATUL K. 18034010009
NANDA HENIK PRATIWI 18034010032
HAFIQYAH NORISTA P. 18034010037

GAMBAR

SPRAY AERATOR

SKALA

1:40

KETERANGAN

LEMBAR KE JUMLAH TANGGAL/ACC

NOZZLE

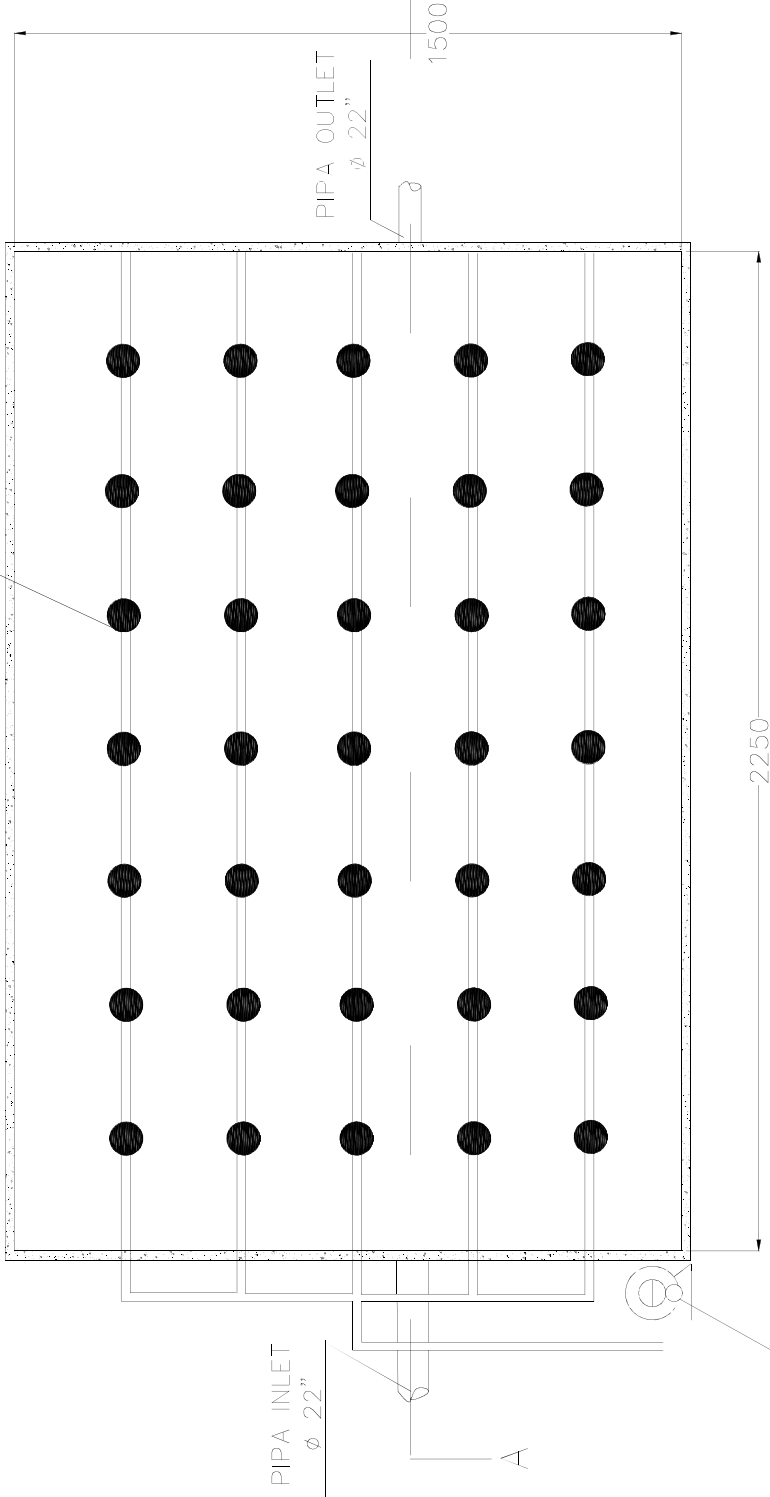

SPRAY AERATOR

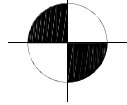



UNIVERSITAS PEMBANGUNAN NASIONAL
"VETERAN" JAWA TIMUR
FAKULTAS TEKNIK
PROGRAM STUDI TEKNIK LINGKUNGAN

MATA KULIAH

TUGAS PBPAM

DOSEN PEMBIMBING

RADEN KOKOH H.P., ST.,MT.,

MAHASISWA

ANA MAUDATUL K.
18034010009
NANDA HENIK PRATIWI
18034010032
HAFIQYAH NORISTA P.
18034010037

NPM

GAMBAR

SLUDGE DRYING BED

SKALA

1:40

KETERANGAN

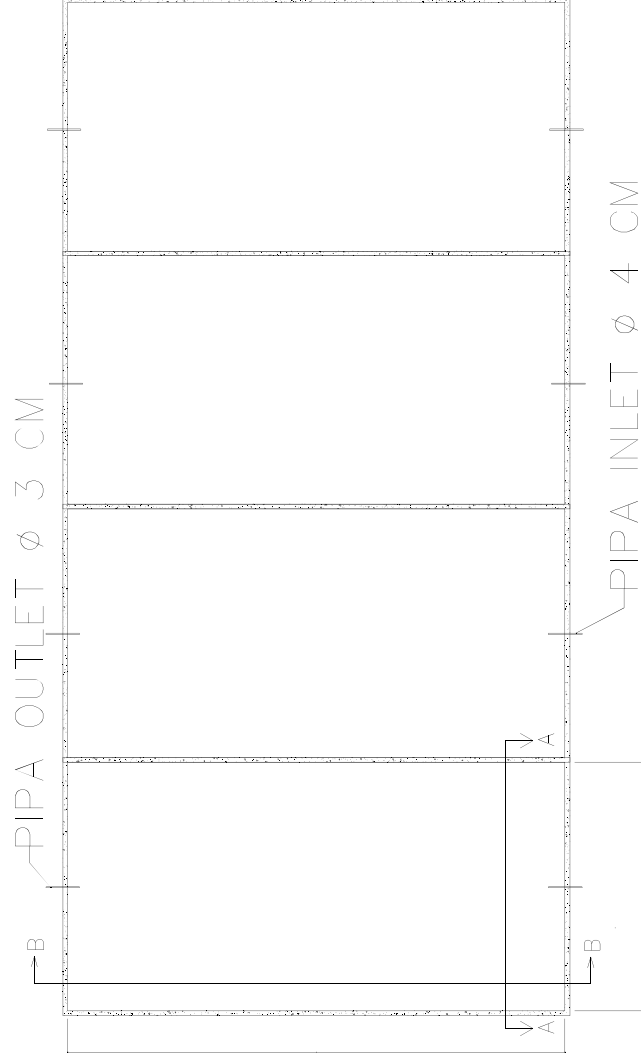

SLUDGE DRYING BED
TAMPAK ATAS

LEMBAR KE	JUMLAH	TANGGAL/ACC



UNIVERSITAS PEMBANGUNAN NASIONAL
"VETERAN" JAWA TIMUR
FAKULTAS TEKNIK
PROGRAM STUDI TEKNIK LINGKUNGAN

MATA KULIAH

TUGAS PBPAM

DOSEN PEMBIMBING

RADEN KOKOH H.P., ST.,MT.,

MAHASISWA

ANA MAUDATUL K.
18034010009
NANDA HENIK PRATIWI
18034010032
HAFIDYA NORISTA P.
18034010037

NPM

GAMBAR

I. COAGULASI

SKALA

1:40

KETERANGAN

LEMBAR KE JUMLAH TANGGAL/ACC

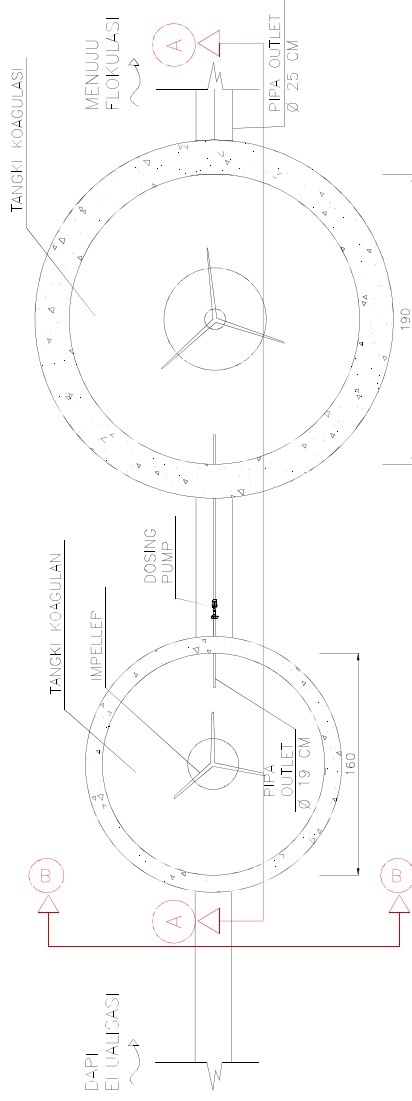

DENAH BAK KOAGULAN DAN
KOAGULASI
TAMPAI ATAS





UNIVERSITAS PEMBANGUNAN NASIONAL
"VETERAN" JAWA TIMUR
FAKULTAS TEKNIK
PROGRAM STUDI TEKNIK LINGKUNGAN

MATA KULIAH

TUGAS PBPAM

DOSEN PEMBIMBING

RADEN KOKOH H.P., ST.,MT.,

MAHASISWA

ANA MAUDATUL K.
NANDA HENIK PRATIWI
HAFIDYA NORISTA P.

NPM

18034010009
18034010032
18034010037

GAMBAR

1. COAGULASI

SKALA

1:40

KETERANGAN

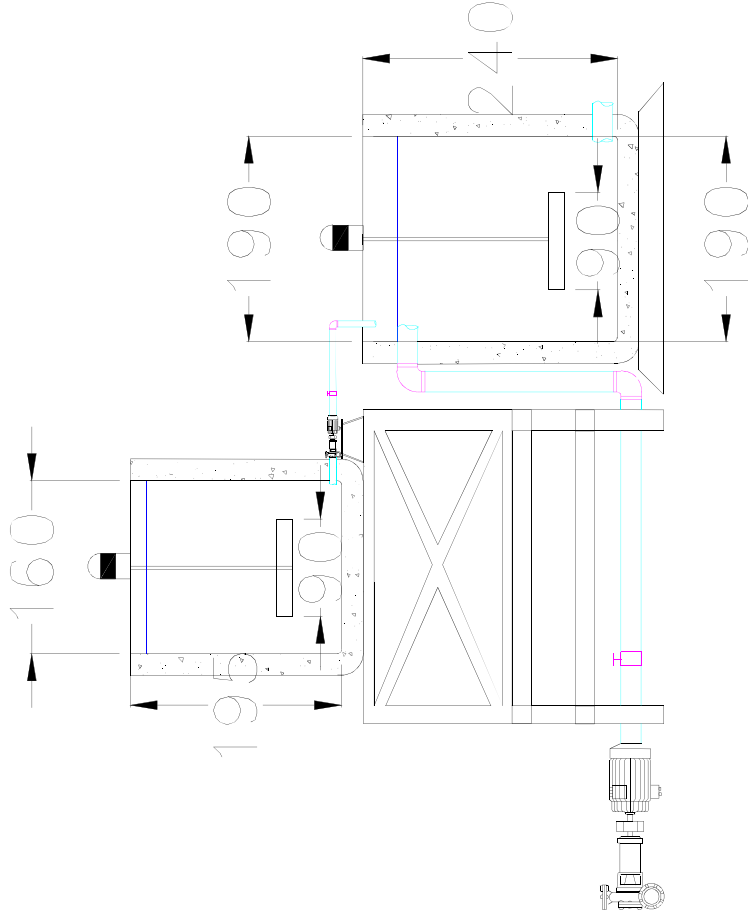

DENAH KOAGULASI
POTONGAN A-A

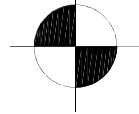

LEMBAR KE JUMLAH TANGGAL/ACC



UNIVERSITAS PEMBANGUNAN NASIONAL
"VETERAN" JAWA TIMUR
FAKULTAS TEKNIK
PROGRAM STUDI TEKNIK LINGKUNGAN

MATA KULIAH

TUGAS PBPAM

DOSEN PEMBIMBING

RADEN KOKOH H.P., ST.,MT.,

MAHASISWA

ANA MAUDIA TULU K.
18034010009
NANDA HENIK PRATIWI
18034010032
HAFIDYA NORISTA P.
18034010037

GAMBAR

1. GAGULASI

SKALA

1: 40

KETERANGAN

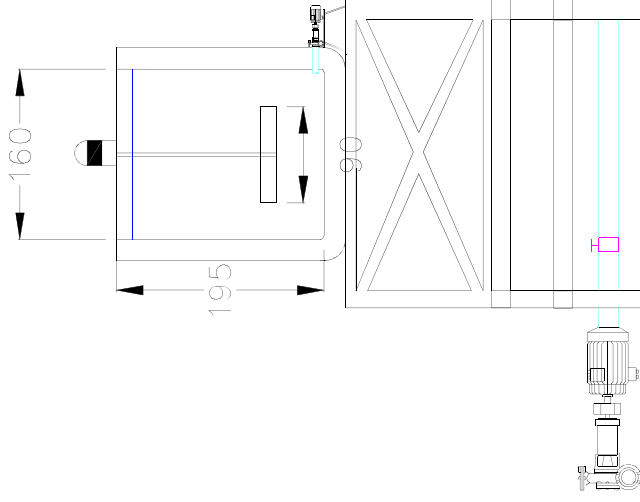

DENAH KOAGULASI
POTONGAN B—B

LEMBAR KE	JUMLAH	TANGGAL/ACC



UNIVERSITAS PEMBANGUNAN NASIONAL
"VETERAN" JAWA TIMUR
FAKULTAS TEKNIK
PROGRAM STUDI TEKNIK LINGKUNGAN

MATA KULIAH

TUGAS PBPAM

DOSEN PEMBIMBING

RADEN KOKOH H.P., ST.,MT.,

MAHASISWA

ANA MAUDATUL K.
18034010009
NANDA HENIK PRATIWI
18034010032
HAFIDYA NORISTA P.
18034010037

GAMBAR

FLOKULASI

SKALA

1:40

KETERANGAN

LEMBAR KE JUMLAH TANGGAL/ACC

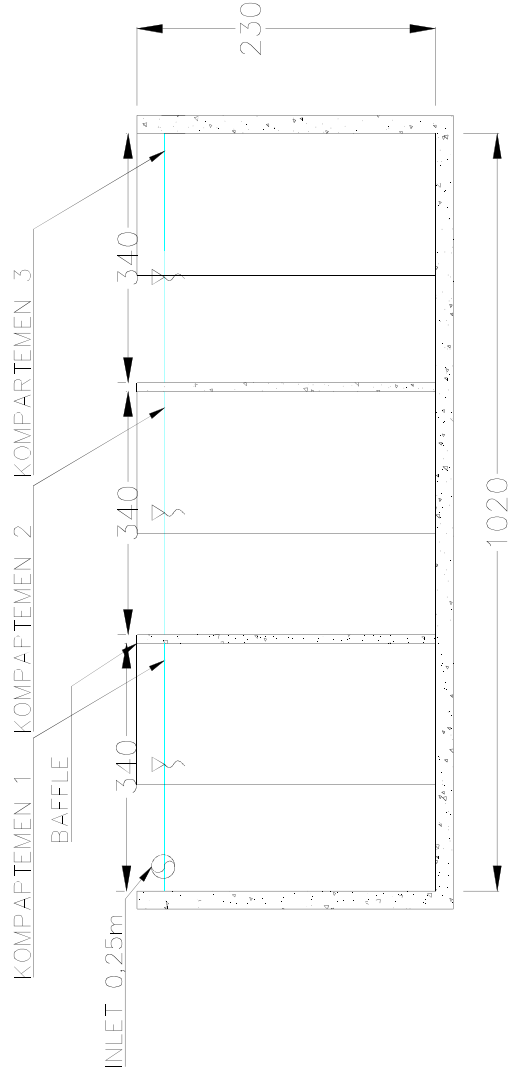

BAK FLOKULASI
POTONGAN A-A



UNIVERSITAS PEMBANGUNAN NASIONAL
"VETERAN" JAWA TIMUR
FAKULTAS TEKNIK
PROGRAM STUDI TEKNIK LINGKUNGAN

MATA KULIAH

TUGAS PBPAM

DOSEN PEMBIMBING

RADEN KOKOH H.P., ST.,MT.,

MAHASISWA

ANA MAUDATUL K.
18034010009
NANDA HENIK PRATIWI
18034010032
HAFIDYA NORISTA P.
18034010037

GAMBAR

FLOKULASI

SKALA

1:40

KETERANGAN

LEMBAR KE	JUMLAH	TANGGAL/ACC

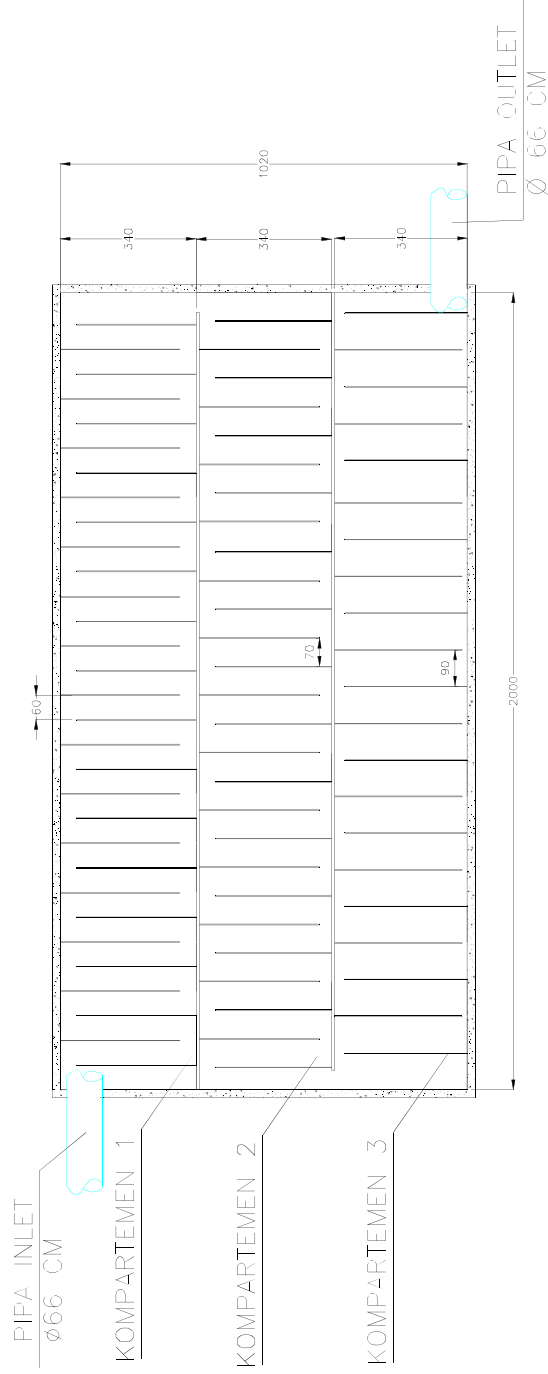



UNIVERSITAS PEMBANGUNAN NASIONAL
"VETERAN" JAWA TIMUR
FAKULTAS TEKNIK
PROGRAM STUDI TEKNIK LINGKUNGAN

MATA KULIAH

TUGAS PBPAM

DOSEN PEMBIMBING

RADEN KOKOH H.P., ST.,MT.,

MAHASISWA

ANA MAULIATUL K.
18034010009
NANDA HENIK PRATIWI
18034010032
HAFIDYA NORISTA P.
18034010037

NPM

GAMBAR

FLOKULASI

SKALA

1:40

KETERANGAN

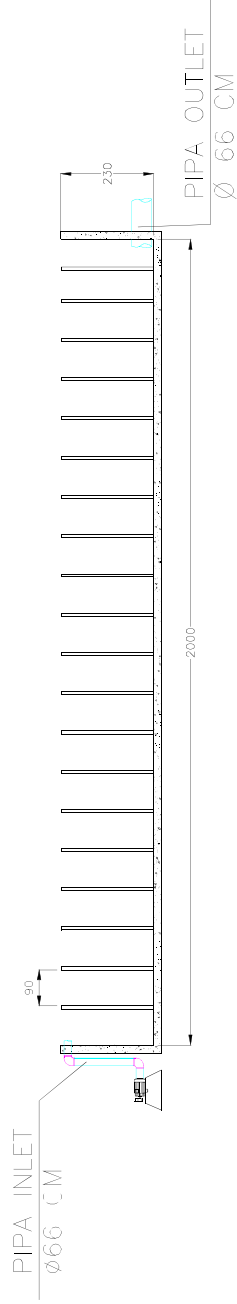

BAK FLOKULASI
POTONGAN A-A

LEMBAR KE	JUMLAH	TANGGAL/ACC



UNIVERSITAS PEMBANGUNAN NASIONAL
"VETERAN" JAWA TIMUR
FAKULTAS TEKNIK
PROGRAM STUDI TEKNIK LINGKUNGAN

MATA KULIAH

TUGAS PBPAM

DOSEN PEMBIMBING

RADEN KOKOH H.P., ST.,MT.,

MAHASISWA

ANA MAUDATUL K.
18034010009
NANDA HENIK PRATIWI
18034010032
HAFIDYA NORISTA P.
18034010037

GAMBAR

FILTPASI

SKALA

1:40

KETERANGAN

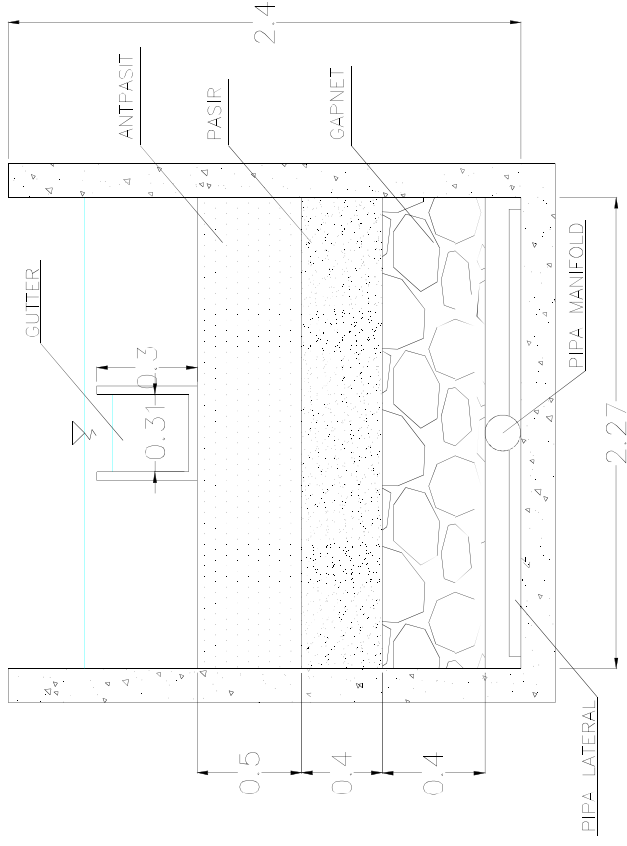

POTONGAN B — B

LEMBAR KE	JUMLAH	TANGGAL/ACC



UNIVERSITAS PEMBANGUNAN NASIONAL
"VETERAN" JAWA TIMUR
FAKULTAS TEKNIK
PROGRAM STUDI TEKNIK LINGKUNGAN

MATA KULIAH

TUGAS PBPAM

DOSEN PEMBIMBING

RADEN KOKOH H.P., ST.,MT.,

MAHASISWA

ANA MAUDATUL K.
18034010009
NANDA HENIK PRATIWI
18034010039
HAFIDYA NORISTA P.
18034010037

GAMBAR

FILTPASI

SKALA

1:40

KETERANGAN

LEMBAR KE JUMLAH TANGGAL/ACC

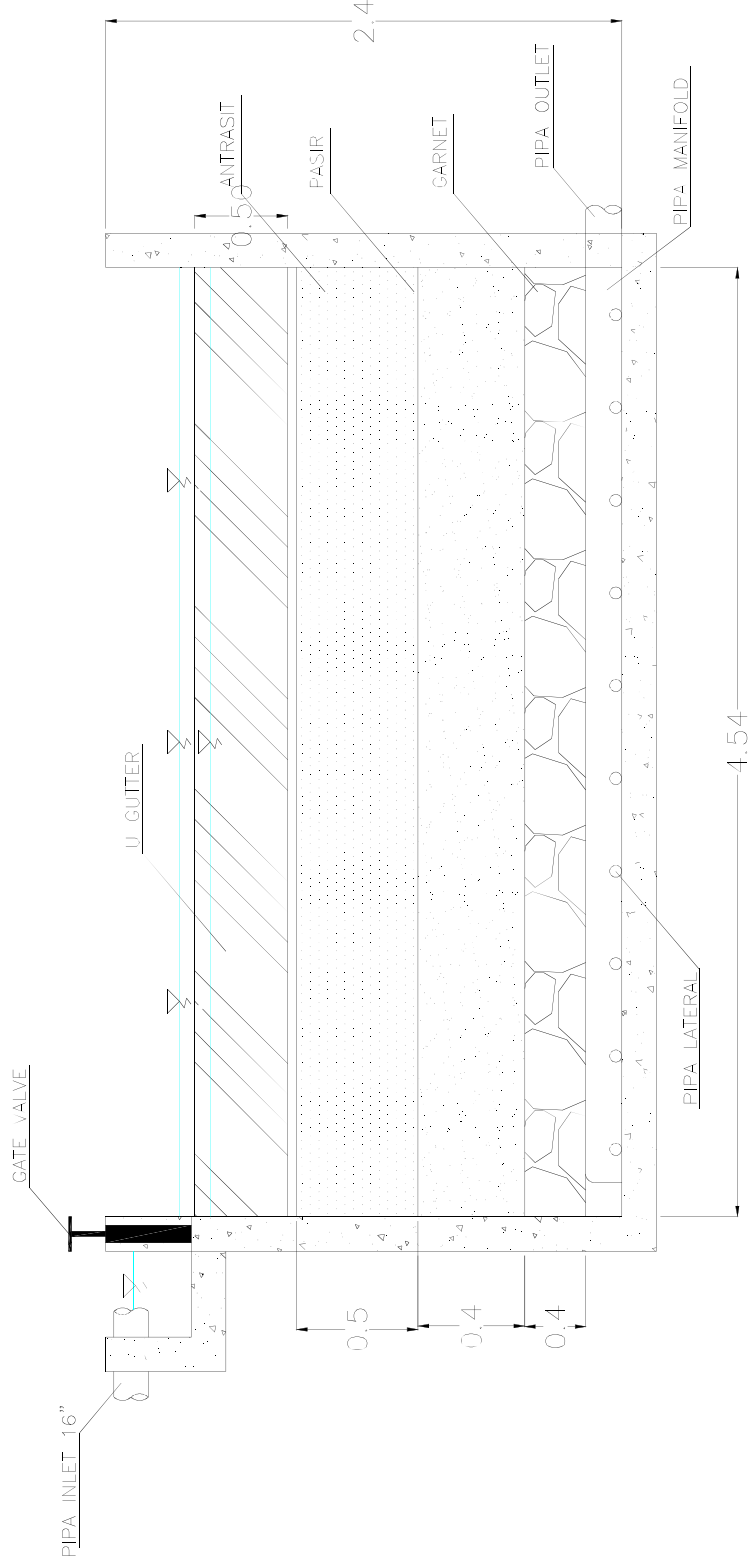

POTONGAN A - A



UNIVERSITAS PEMBANGUNAN NASIONAL
"VETERAN" JAWA TIMUR
FAKULTAS TEKNIK
PROGRAM STUDI TEKNIK LINGKUNGAN

MATA KULIAH

TUGAS PBPAM

DOSEN PEMBIMBING

RADEN KOKOH H.P., ST.,MT.,

MAHASISWA

ANA MAUDIA TULU K.
18034010009
NANDA HENIK PRATIWI
18034010032
HAFIQYA NORISTA P.
18034010037

NPM

GAMBAR

SEDIMENTASI

SKALA

1:40

KETERANGAN

LEMBAR KE	JUMLAH	TANGGAL/ACC

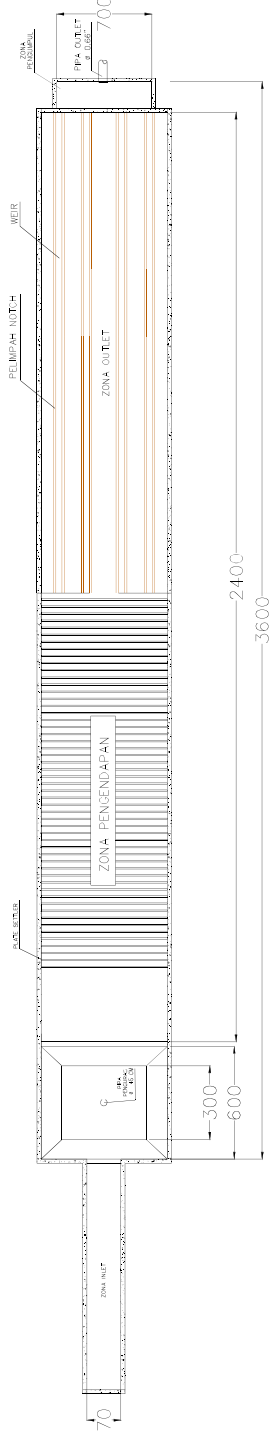

SEDIMENTASI
TAMPAK ATAS



UNIVERSITAS PEMBANGUNAN NASIONAL
"VETERAN" JAWA TIMUR
FAKULTAS TEKNIK
PROGRAM STUDI TEKNIK LINGKUNGAN

MATA KULIAH

TUGAS PBPAM

DOSEN PEMBIMBING

RADEN KOKOH H.P., ST.,MT.,

MAHASISWA

NPM

ANA MAUDIA TUL K
18034010009
NAIDA HENIK PRATIWI
18034010032
HAFIDYA NORISTA P.
18034010037

GAMBAR

SKALA

SEDIMENTASI

1:40

SEDIMENTASI
POTONGAN A-A

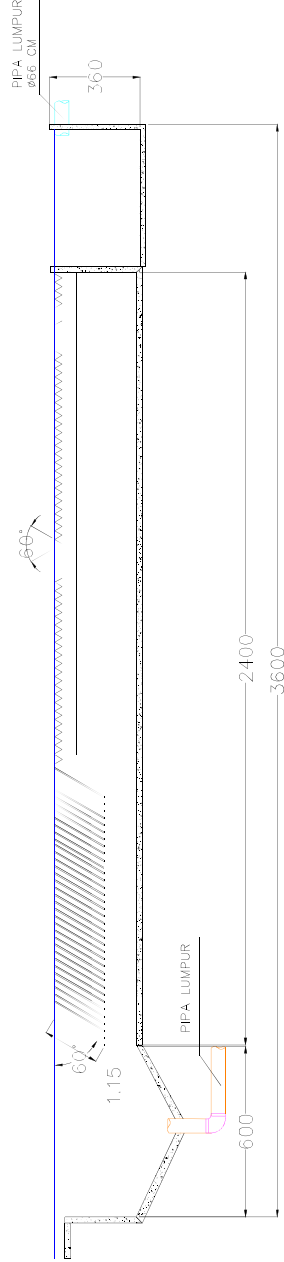

LEMBAR KE

JUMLAH

TANGGAL/ACC



UNIVERSITAS PEMBANGUNAN NASIONAL
"VETERAN" JAWA TIMUR
FAKULTAS TEKNIK
PROGRAM STUDI TEKNIK LINGKUNGAN

MATA KULIAH

TUGAS PBPAM

DOSEN PEMBIMBING

RADEN KOKOH H.P., ST.,MT.,

MAHASISWA

ANA MAUDATUL K.
18034010009
NANDA HENIK PRATIWI
18034010032
HAFIDYA NORISTA P.
18034010037

GAMBAR

1. LOPINASI

SKALA

1:40

KETERANGAN

LEMBAR KE JUMLAH TANGGAL/ACC

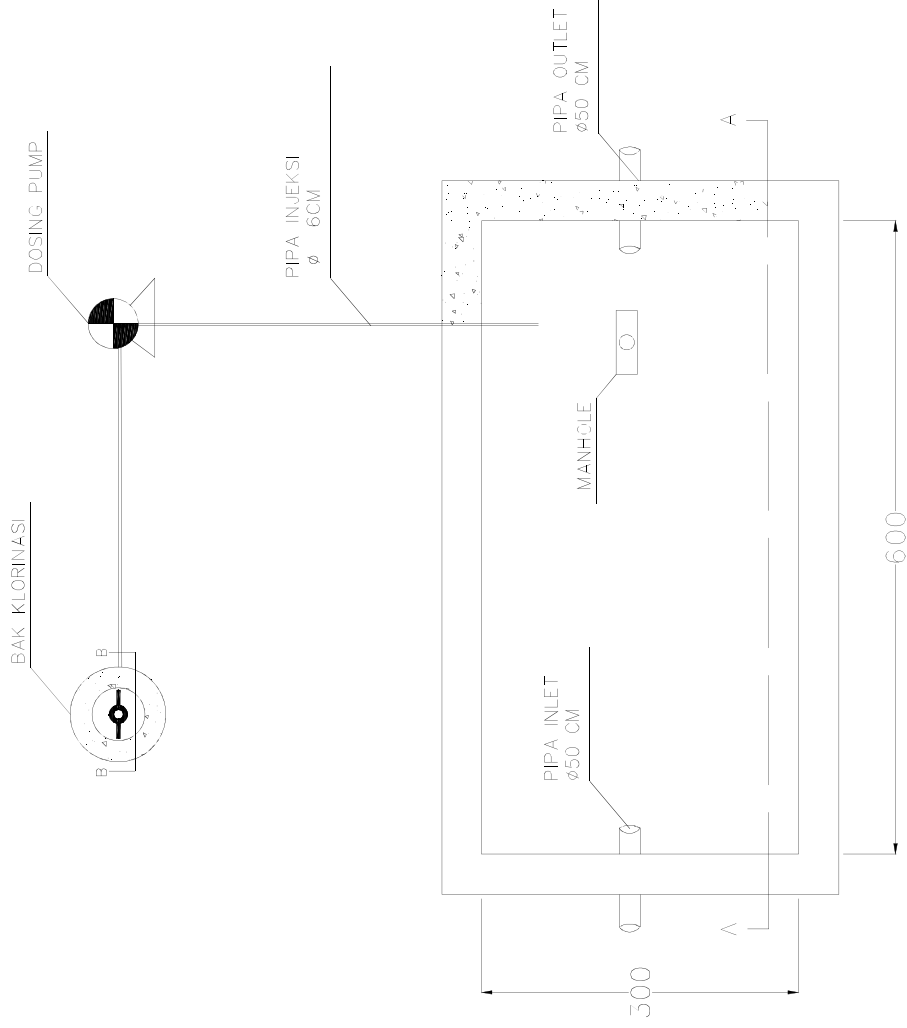

DENAH BAK KLORINASI DAN BAK PENAMPUNG





UNIVERSITAS PEMBANGUNAN NASIONAL
"VETERAN" JAWA TIMUR
FAKULTAS TEKNIK
PROGRAM STUDI TEKNIK LINGKUNGAN

MATA KULIAH

TUGAS PBPAM

DOSEN PEMBIMBING

RADEN KOKOH H.P., ST.,MT.,

MAHASISWA

ANA MAUDJATUL K.
NANDA HENIK PRATIWI
HAFIDYA NORISTA P.

NPM

18034010009
18034010009
18034010032
18034010037

GAMBAR

1 LOPINASI

SKALA

1:40

KETERANGAN

LEMBAR KE JUMLAH TANGGAL/ACC

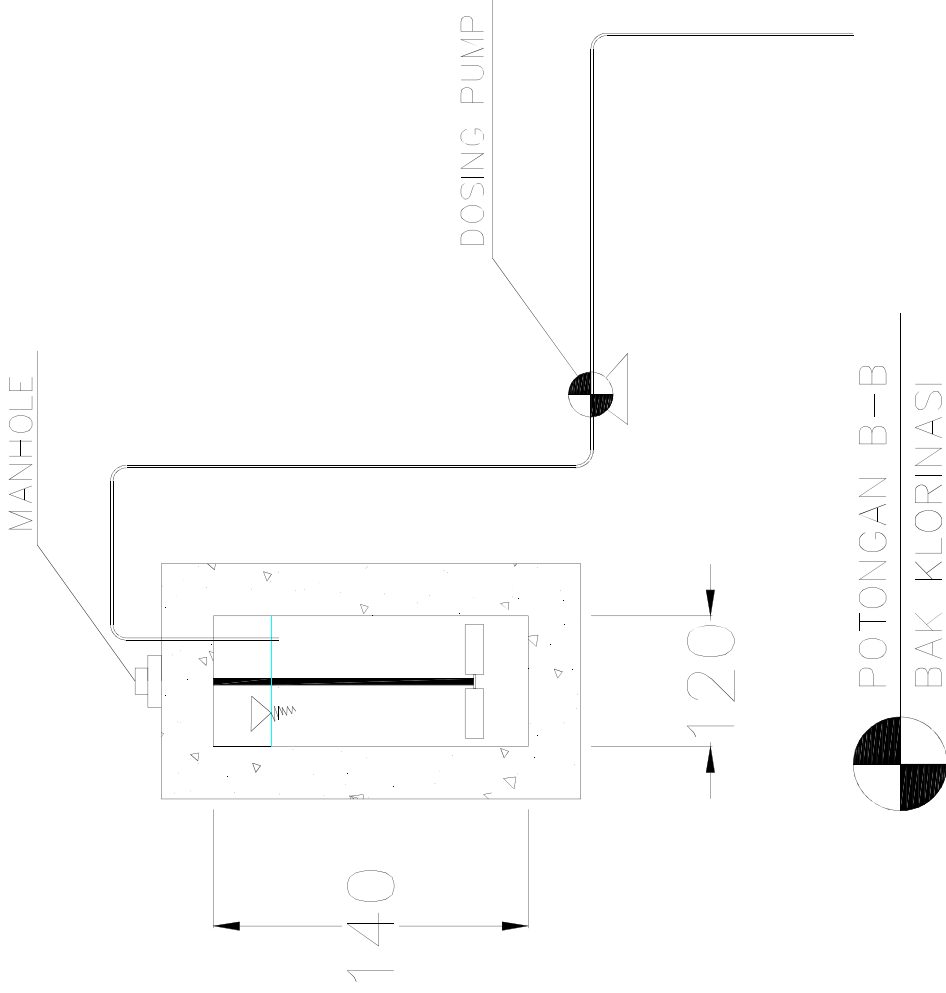



UNIVERSITAS PEMBANGUNAN NASIONAL
"VETERAN" JAWA TIMUR
FAKULTAS TEKNIK
PROGRAM STUDI TEKNIK LINGKUNGAN

MATA KULIAH

TUGAS PBPAM

DOSEN PEMBIMBING

RADEN KOKOH H.P., ST.,MT.,

MAHASISWA

NPM

ANA MAUDATUL K. 18034010009
NANDA HENIK PRATIWI 18034010032
HAFIQYAH NORISTA P. 18034010037

GAMBAR

SKALA

1 LOPINASI

1:40

KETERANGAN

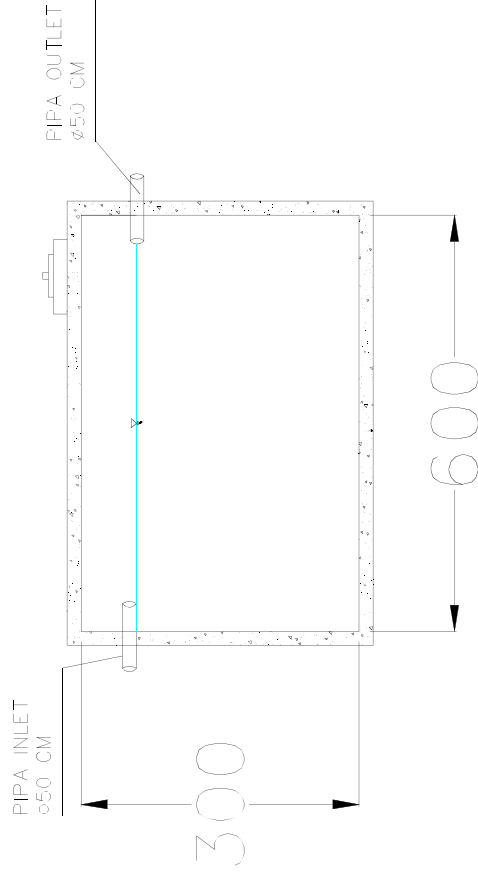

POTONGAN A-A
BAK PENAMPUNG

LEMBAR KE	JUMLAH	TANGGAL/ACC



UNIVERSITAS PEMBANGUNAN NASIONAL
"VETERAN" JAWA TIMUR
FAKULTAS TEKNIK
PROGRAM STUDI TEKNIK LINGKUNGAN

MATA KULIAH

TUGAS PBPAM

DOSEN PEMBIMBING

RADEN KOKOH H.P., ST.,MT.,

MAHASISWA

ANA MAUDATUL K.
NANDA HENIK PRATIWI
HAFIDYA NORISTA P.

NPM

18034010009
18034010039
18034010037

GAMBAR

SLUDGE DRYING BED

SKALA

1:40

SLUDGE DRYING BED
POTONGAN B-B

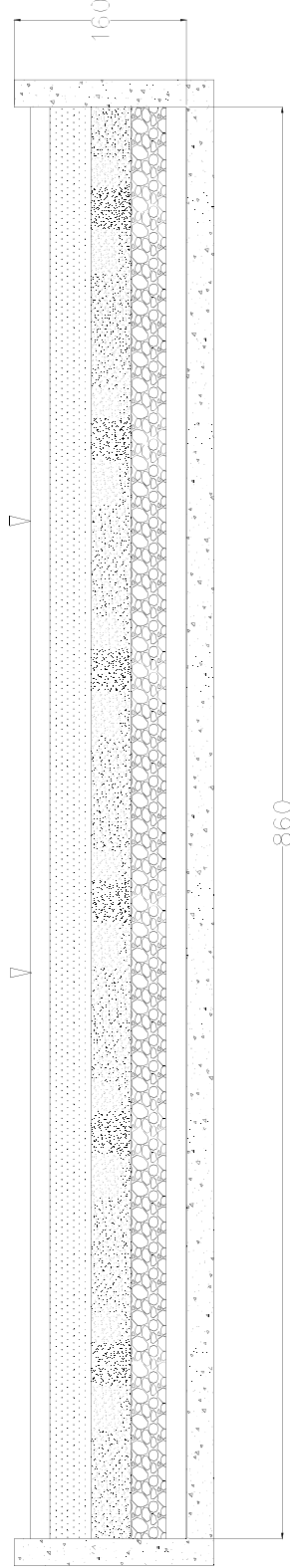

LEMBAR KE JUMLAH TANGGAL/ACC



UNIVERSITAS PEMBANGUNAN NASIONAL
"VETERAN" JAWA TIMUR
FAKULTAS TEKNIK
PROGRAM STUDI TEKNIK LINGKUNGAN

MATA KULIAH

TUGAS PBPAM

DOSEN PEMBIMBING

RADEN KOKOH H.P., ST.,MT.,

MAHASISWA

ANA MAUDATUL K. 18034010009
NANDA HENIK PRATIWI 18034010039
HAFIDYA NORISTA P. 18034010037

NPM

GAMBAR

SLUDGE DRYING BED

SKALA

1:40

KETERANGAN

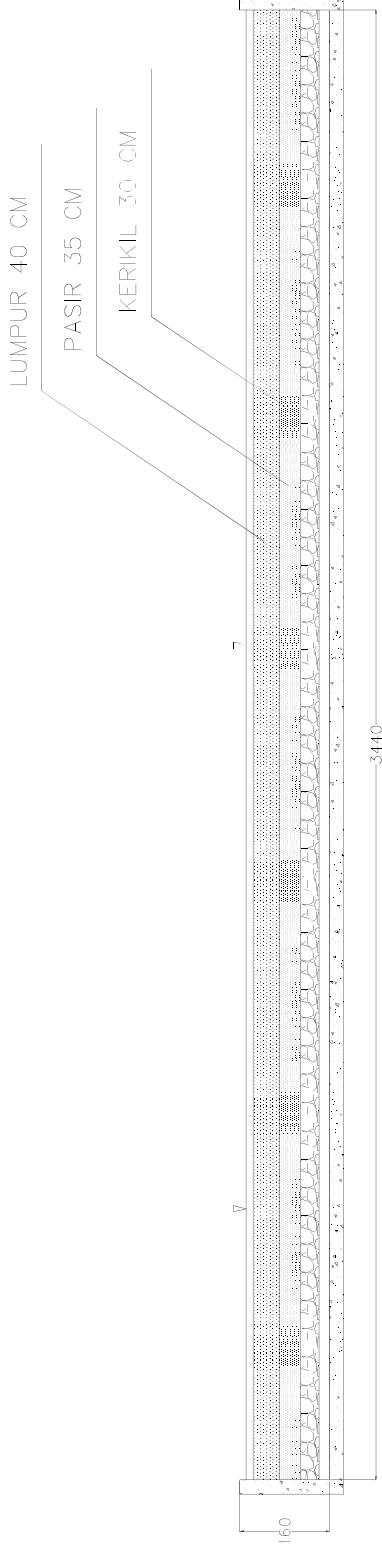

SLUDGE DRYING BED
POTONGAN A-A

LEMBAR KE	JUMLAH	TANGGAL/ACC





PROGRAM STUDI TEKNIK LINGKUNGAN
FAKULTAS TEKNIK
UNIVERSITAS PEMBANGUNAN NASIONAL "VETERAN" JAWA TIMUR

TUGAS : PERANCANGAN BPAM
NAMA : ANA MAUIDATUL K., NANDA HENIK P., HAFIDYA NORISTA P.
N.P.M : 18034010008, 18034010023, 18034010037
PEMBIMBING : RADEN KOKOH HARYO PUTRO, ST., MT.

NO	TANGGAL	URAIAN	TTD PEMBIMBING
1	Jumat, 10 Sept. 2021	<ul style="list-style-type: none">- Kontrak asistensi dan rules asistensi- Menentukan sungai dan lokasi- Menentukan parameter air sungai (air baku)- Menentukan baku mutu air minum (Permenkes No. 492 Tahun 2010)- Pemberian parameter, kadar pencemar, debit, dan luas lahan oleh dosen pembimbing	
2	Jumat, 17 Sept. 2021	<ul style="list-style-type: none">- Asistensi alternative unit pengolahan- Alternatif 1: apakah BAF bisa untuk meremoval ammonia? Cari referensi unit lain- Proses yang bisa meremoval ammonia?- Tipe disinfeksi bebas- Teknologi filtrasi bebas, tanpa memperhatikan anggaran- Kriteria desain dibuat setelah pemilihan alternatif desain fix	
3	Jumat, 24 Sept. 2021	<ul style="list-style-type: none">- Alternatif pengolahan ok- Tambahkan neraca massa- Lengkapi kriteria perencanaan untuk tiap unit- Cari referensi tambahan dan mengkaji ulang kriteria perencanaan unit- Lanjutkan perhitungan unit	
4	Jumat, 8 Okt. 2021	<ul style="list-style-type: none">- Mempelajari rumus-rumus yang dipakai- Cek headloss pipa suction- Melanjutkan perhitungan prasedimentasi	
5	Senin, 25 Okt. 2021	<ul style="list-style-type: none">- Mencari referensi % diskrit dan grit- Memperbaiki gambar prasedimentasi (outlet)- Ganti referensi untuk unit aerasi- Membuat gambar aerasi	
6	Senin, 1 Nov. 2021	<ul style="list-style-type: none">- Untuk koagulasi ditambah perhitungan rpm- Melanjutkan perhitungan selanjutnya	
7	Senin, 8 Nov 2021	<ul style="list-style-type: none">- Koordinasi dengan pak kokoh mengenai kekeruhan dan TSS- Koordinasi dengan pak kokoh mengenai filtrasi (backwash)	



PROGRAM STUDI TEKNIK LINGKUNGAN
FAKULTAS TEKNIK
UNIVERSITAS PEMBANGUNAN NASIONAL "VETERAN" JAWA TIMUR

8	Jumat, 19 Nov. 2021	<ul style="list-style-type: none">- Perhitungan filtrasi ok- untuk perhitungan reservoir masih belum efektif. Pelajari lagi materi plambing	
9	Senin, 29 Nov. 2021	<ul style="list-style-type: none">- Tambahkan gambar potongan- Gambar kompressor, pompa sesuaikan notasi- Cek peletakan pipa inlet outlet- Dimensi dirapikan lagi	
10	Senin, 6 Des. 2021	Final Check	